

Guideline for Rescue Services Electric Vehicle

eCANTER

Disclaimer

The vehicles from Mitsubishi Fuso are traditionally always state of the art, which applies particularly to vehicle safety.

This rescue guide is part of our comprehensive safety concept and supplements the information on the vehicle-specific rescue card currently available for the New Generation eCanter. In this way, we provide rescue services with up-to-date specific details on our vehicles and their electrical safety and drive systems. This rescue guide is intended exclusively for trained rescue personnel and first responders.

The following are essential components of this rescue guide Information on new drive technologies, e.g., electric vehicles with high-voltage batteries. Compared with conventional vehicles, the new electric drive technologies require additional measures to handle vehicles involved in accidents safely. We would like to explicitly point out that this rescue guide makes no claim to completeness and in no way can or is intended to be a replacement for profound training and relevant technical literature. Always observe country-specific laws and guidelines.

Introduction

The chapters of this rescue guide follow, in principle, the main actions to be taken at the accident site, supplemented by concepts for specific accident situations (e.g., the fire of vehicles equipped with lithium-ion high-voltage batteries or rescue of vehicles that are underwater).

Only vehicles and equipment that are in factory condition will be considered. Retrofit solutions and conversions that Mitsubishi Fuso disapproves are not considered. Identifying the vehicle involved in the accident is of significant importance since, depending on the model, different actions must be taken into account.

In the field of electric mobility, Mitsubishi Fuso currently offers the following drivetrain types:

BEV – Battery Electric Vehicle

These vehicles are powered purely by an electric motor. The energy required for this comes from a traction battery. They always have a connection for charging the traction battery from an external power supply.

HEV – Hybrid Electric Vehicle

Vehicles with two combined drive systems. The electric drive is linked to the combustion engine.

This manual contains important cautionary instructions and supplementary information under the following four headings which identify the nature of the instructions and information:



Precautions that should be taken in handling potentially dangerous substances, such as battery fluid and coolant additives.



Precautionary instructions, which if not observed, could result in serious injury or death.



Precautionary instructions, which if not observed, could result in damage to or destruction of equipment or parts.

NOTE:

Suggestions or supplementary information for more efficient use of equipment or better understanding.

Electric vehicles, in general

1 Identification

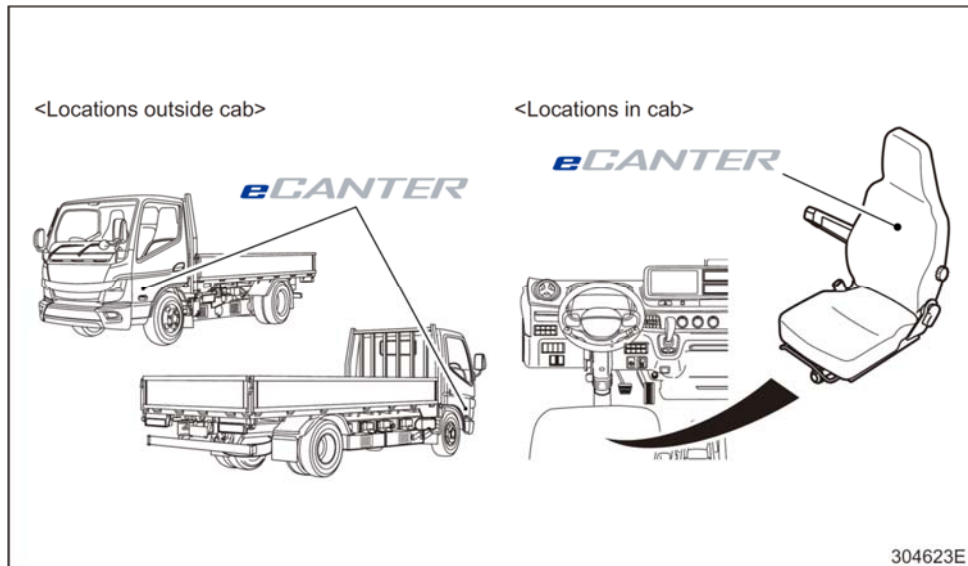

2 Characteristics to recognize electric vehicles

"Warning: high voltage" label. These labels must be visibly attached to all HV components (possibly several times, depending on the installation situation and whether there are still removable lids/flaps, detachable parts, or similar) regardless of whether the component is damaged or not.

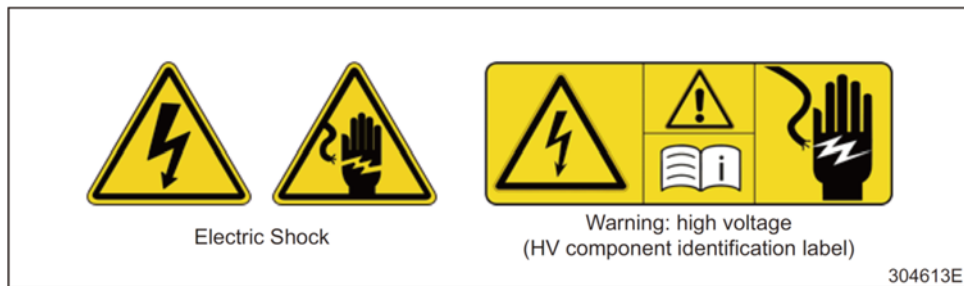

They are charging port. Charging port may be located behind flaps or covers. There is no exact position where a charging port found located. This is up to the manufacturers themselves. In the case of the eCanter, it is located behind the driver's cab or at the end of the vehicle.

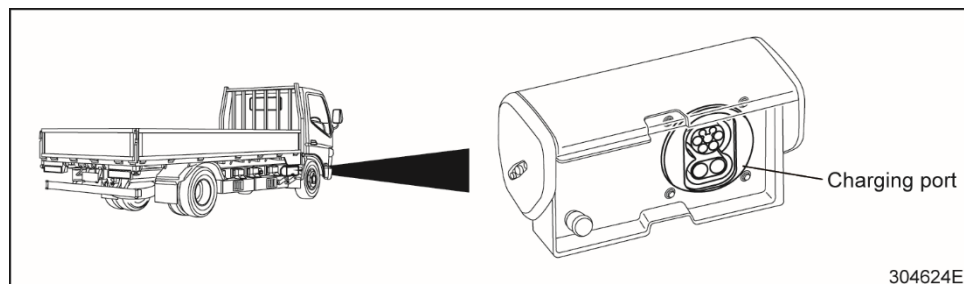

Instrument Cluster Display. In the instrument cluster, there is a battery charge indicator, a status indicator on the condition of the electric drive system, and the status indicator on the vehicle is operating status ("READY").

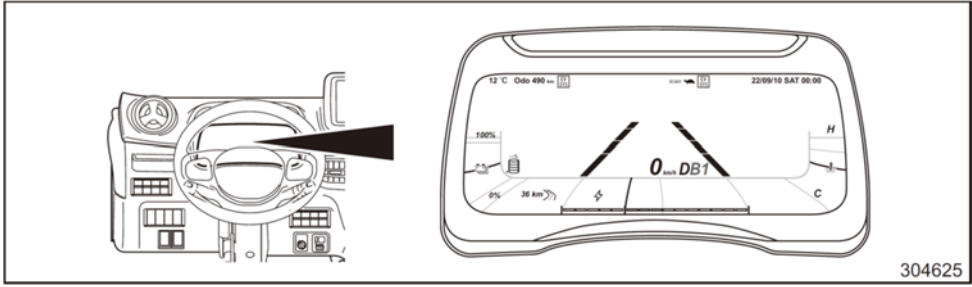

First Rescue Actions

Electric vehicles have components and systems that can be active even when the vehicle is in an accident or parked, and the internal combustion engine or electric drive system is switched off. Depending on the accident situation, it may not be possible to determine whether the vehicle is "ON" or "OFF". Generally, it should be assumed that each vehicle is "ON" when approached. Before starting rescue operations, it is essential to ensure the vehicle is switched off (see chapter "Switching off the drive system"). In addition, it is recommended to secure an accident vehicle with chocks or other objects to prevent it from rolling away.

⚠ WARNING

Risk of injury due to unintentional movement of the vehicle or chassis. The vehicle must be secured and stabilized before work.

Possible fixing points are generally axles, longitudinal and transverse beams, and trailer couplings. Tension belts and slings should be applied over several points to achieve the best balance of the vehicle load. In addition, the securing of the cargo should be addressed, especially in the case of dangerous goods.

The driver's cab should be secured to enable the most gentle rescue possible. This means that the person involved in the accident should not be subjected to any unnecessary movements. Consequently, the cab suspension, if present, and the suspension between the vehicle and the axles must be disabled or bridged to prevent excessive movement of the cab or vehicle.

To secure against unnecessary movement, for example, a tension belt can be used, which is either led from the front wheel rim, over the cab, to the other front wheel rim. However, it must be ensured that the following rescue measures are not impeded. It should also be evaluated whether the driver's cab must be secured against the frame, as the driver's cab may slip off due to destroyed cab mounts.

⚠ CAUTION

It should be avoided that jacks or objects for supporting or holding the vehicle are placed on the high-voltage lithium-ion battery, or components of the drive train (drive module), as this can lead to damage with a high-risk potential.

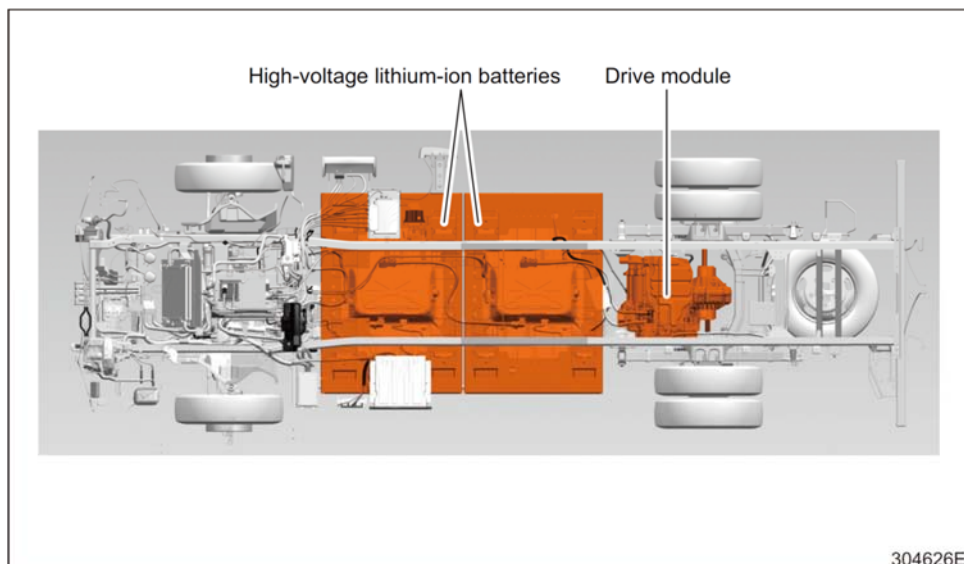

Removing electric vehicles from the immediate danger zone at low speeds (≤ 5 km/h | ≤ 3 m/h) is permissible in principle.

Characteristics of accidents

1 Minor accidents

Characteristics:

- The airbag was not deployed.
- The vehicle frame is intact.
- All high-voltage components and the electric drive system are undamaged.
- The high-voltage battery and the protective frame are undamaged.

Proceeding:

- Switch off the ignition and secure the vehicle against rolling away.
- Operate the high-voltage shut-off switch and secure it against being switched on again, e.g., using a padlock.

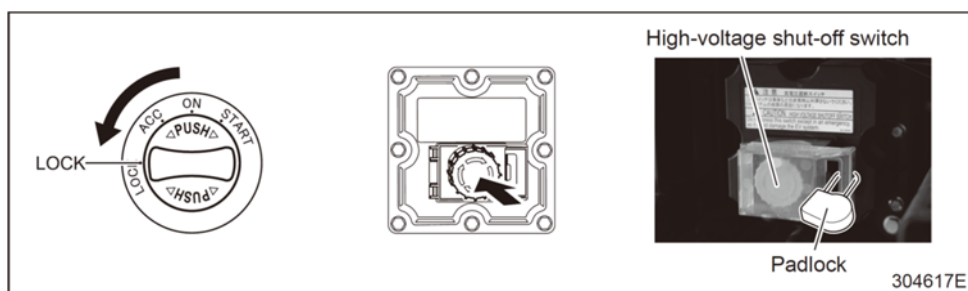

2 Severe accident

Characteristics:

- The airbag was deployed.
- Or/and the vehicle frame is damaged.
- Or/and high-voltage components or/and the electric drive system is damaged.
- Or/and the high-voltage battery or/and the protective frame is damaged.

Proceeding:

- Switch off the ignition and secure the vehicle against rolling away.
- Operate the high-voltage shut-off switch and secure it against being switched on again, e.g., using a padlock.

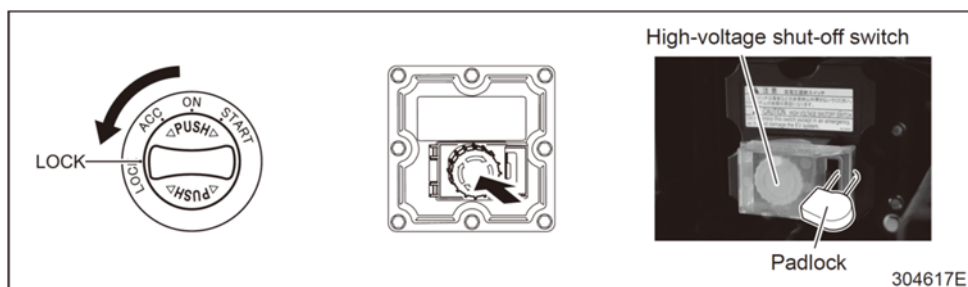

3 During Charging

Characteristics:

- The airbag was not deployed.
- The high-voltage battery may still be active.
- Vehicle is connected to the charging station.
 - If the charging cable and/or the charging station are damaged during the charging process, this case is covered by the technical infrastructure of the charging station. The charging station needs to shut down.
- Or/and the high-voltage battery or/and the protective frame is damaged.

Proceeding:

- Switch off the ignition and secure the vehicle against rolling away.
- Operate the high-voltage shut-off switch and secure it against being switched on again, e.g., using a padlock.
- If the high-voltage battery is damaged, please observe chapter 5.5.
- If possible, contact the hotline of the charging station operator.
- Check the charging cable and charging cable plug for visible damage. Do not touch damaged areas.
- Before disconnecting the charging cable from the vehicle socket, the vehicle must be unlocked.
- End the charging process by pressing the charging stop button on the part of the vehicle or the charging station.

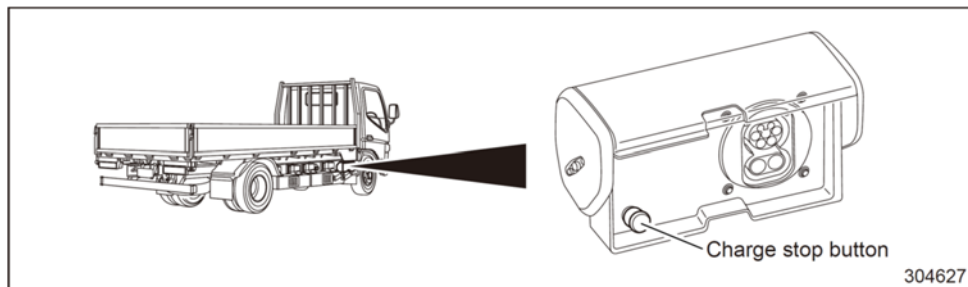

- The charging cable plug is unlocked and can be removed.
- In the event of a non-functional 12/24 V electrical system or an electrical fault, the charging cable plug can be unlocked by pulling on the mechanical release and then disconnected.

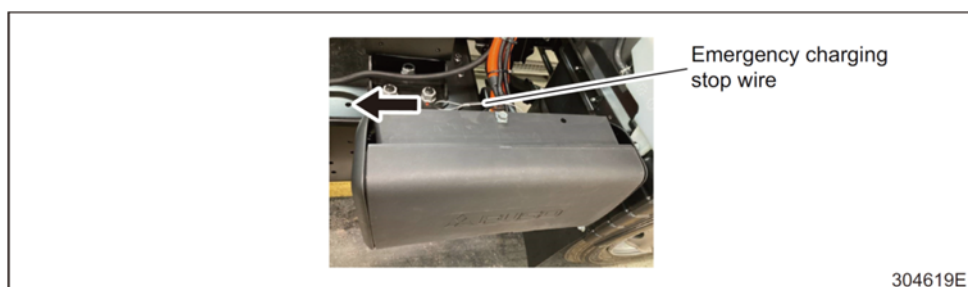

⚠ WARNING

During an active charging process, the mechanical release must not be actuated, as there is a risk of fatal injury. It must always be ensured that the charging process via the charging station or the vehicle has been finished first.

Switching off the drive system

1 Automatic deactivation of the high-voltage drive system in an accident situation

⚠ WARNING

Damaged or defective high-voltage system components, orange-colored cables, and non-insulated electrical connections and lines should not be touched.

The basic structure of the high-voltage electrical system and the rescue instructions derived from it are independent of the vehicle type.

Protection on the system side against hazards of electric current:

- All components that are operated with high voltage have contact protection. This, if undamaged, ensures adequate protection against the dangers of electric current.
- Automatic shutdown in case of a short circuit to avoid cable overload.
- Shutdown of the high-voltage electrical system depending on the severity and type of accident from the front and the side by means of crash sensors.
- All-pole disconnection of the high-voltage vehicle electrical system from the energy storage system.
- Deactivation of the generator function of the electric drive and blocking of the DC/DC converter.
- Active discharge of the capacitors.

NOTE:

The SOC (state of charge) of the high-voltage battery or individual cells inside the high-voltage battery remains unchanged after deactivation of the high-voltage vehicle electrical system, but the high-voltage battery is then electrically isolated from the rest of the high-voltage vehicle electrical system.

2 Manual switching off the high-voltage electrical system

An important aspect of the rescue of injured persons is **self-protection**. In this section, we will look at the dangers that exist for both casualties and rescue workers and what measures can be taken to minimize the risk.

⚠ WARNING

Self-protection is the first priority in all rescue measures in the first place. Suitable protective equipment must be worn at all times and adapted to the situation.

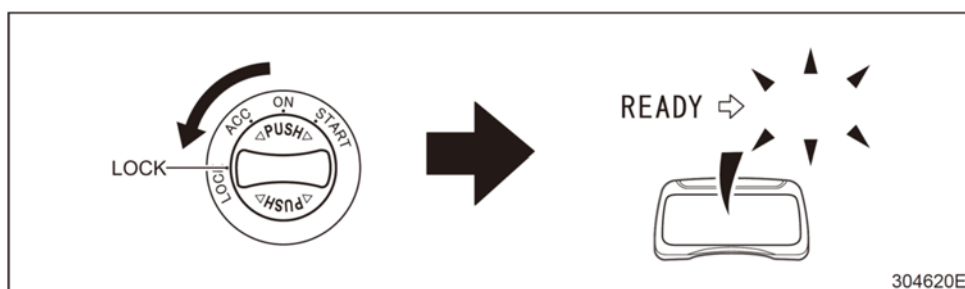

⚠ CAUTION

Vehicles with keyless start. The starter switch is located near the steering wheel. After pressing it to switch off the drive system, the vehicle key should be kept at least 5m away to avoid the drive system's accidental starting.

Mitsubishi Fuso electric trucks are always equipped with an high-voltage shut-off switch. In addition, the high-voltage batteries have a Manual Service Disconnect (MSD).

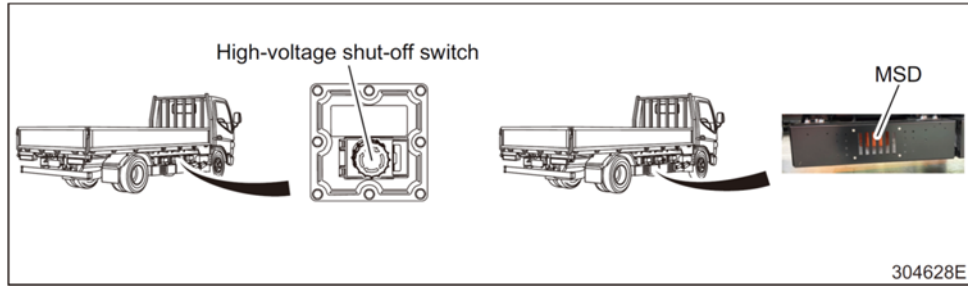

To operate the high-voltage shut-off switch, remove or flip open the cover. Press the red switch down until you hear a clicking sound.

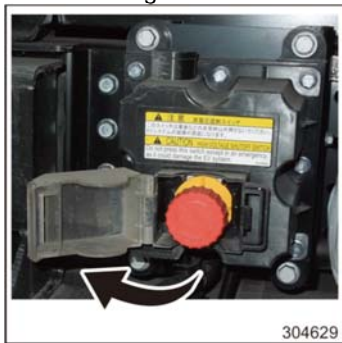

Open the flap

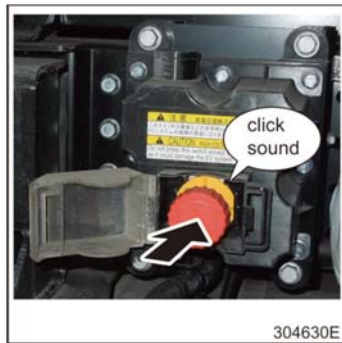

Operate the emergency stop

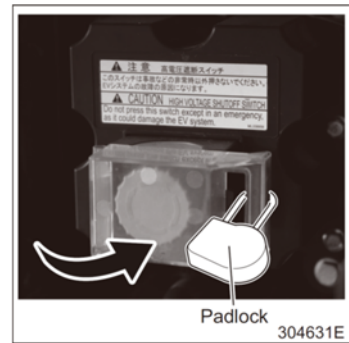

Until click sound

To operate the manual service disconnect, first unlock the safety latch, then the lever, and pull it so that HV+ and HV- are physically separated from each other.



Unlock



Release



Pull

⚠ WARNING

- **Manual Service Disconnect.** If the MSD is to be removed, be sure to wear full personal protective equipment (PPE). The MSD may only be operated by specialists. The high-voltage shut-off switch can be operated by anyone in an emergency.
- **Orange-colored high-voltage cables** must not be touched at damaged points or cut in order to switch off the electric drive system. Not even in the event of an accident.

3 Determine the absence of voltage in the high-voltage vehicle electrical system

NOTE:

A direct indication of the absence of voltage after an accident is impossible due to the wide variety of damage scenarios.

Even if the high-voltage electrical system appears to be de-energized, the vehicle's high-voltage electrical system must always be de-energized manually (see information in section 4.2 and in the vehicle-specific rescue card).

Hazards and countermeasures

1 General

Fire and explosion hazards due to short circuits, thermal runaway, and escaping gas. Risk of burns and injury due to chemical burns to eyes and skin because of leaking battery electrolyte or mist, short circuits, thermal runaway, and exposure to electric arcs. Risk of poisoning due to ingestion of leaking battery electrolyte or gas inhalation. Life-threatening danger due to electrical voltages $U \geq 30$ V AC and $U \geq 60$ V DC on damaged or defective electric components, cables, and connectors. The risk of UV radiation due to arcs can damage the retina or skin. Risk of secondary accidents due to uncontrolled system behavior, environmental variables, and electric arcs.

CAUTION

Open fire, sparks, and smoking are prohibited in the immediate vicinity of the accident site.

If the vehicle's electrical system is still switched on, uncontrolled vehicle movements may occur, leading to further hazards.

The high-voltage electrical system is equipped with insulated orange-colored cables. The basic structure of the high-voltage electrical system and the resulting rescue instructions are independent of the vehicle type.

2 Risk of electric shock or vehicle fire

In the event of a vehicle fire, high-voltage components and high-voltage cables can be severely damaged. Due to the wide variety of damage scenarios, a direct indication of the voltage-free status after an accident is impossible. The safety technology in the vehicle only takes effect if the fault is detected by the vehicle electronics and can still be technically controlled after an accident. The emergency responders need to assess the degree of damage to the electrical system and any reduced effectiveness of the safety systems.

In particular, there is a risk of fire and explosion in the event of an internal short circuit of the battery cells inside the high-voltage battery or a thermal runaway. Closed degassing or electrolyte outlet openings can lead to an overpressure in the battery housing, which in turn can lead to the sudden release of gases or an explosion of the battery.

Electrical shocks can cause involuntary muscle contractions, irregular heartbeat, ventricular fibrillation, cardiac arrest, respiratory arrest, burns, or other cellular damage.

The severity of the injury depends on the current intensity, type of current, frequency of the current, duration of exposure, and the path through the human body.

Life-threatening danger due to voltages ≥ 30 V Alternating Current (AC) or ≥ 60 V Direct Current (DC). The voltage ratings are in accordance with UN Regulation No. 100 (UN ECE-R 100), which is the standard for high-voltage electrical systems in electric vehicles.

Risk of injury and burns due to electric arcs, e.g., by disconnecting battery terminals or unplugging connectors under load. Arcing can occur due to short circuits. Exposure to arcs can cause 1st to 4th-degree burns, flashing of the eyes due to strong UV light (similar to welding), blast trauma, and injuries due to moving components. In the event of a short-circuit from positive to negative, the battery connections and short-circuit-causing conductive objects, such as tools or jewelry (watches, rings or metallic belt buckles, etc.), as well as the battery, become hot within seconds and hot/liquid metal splashes can be unleashed.

Protective measures and rules of behavior

- Because of the presence of electrical energy, special safety distances must be maintained when fighting fires.
- Firefighting with personal protective equipment and self-contained breathing protection.
- Avoid touching damaged parts (e.g., damaged or exposed components, defective or torn wires, and cables).
- Use rescue equipment with caution. Cutting or deforming the vehicle body with rescue equipment in the area of high-voltage cables and components should be avoided.

- Separated components of high-voltage energy storage systems are to be picked up from the ground only with electrically isolated equipment. The further procedure is to be decided depending on the situation and location.
- In case of unavoidable rescue measures in areas with damaged high-voltage components, high-voltage cables, and high-voltage batteries, cover them with a suitable, electrically insulating, flexible cover.
- Manually deactivate the vehicle's high-voltage system, and disconnect the 12V/24V battery if possible.

In the event of a fire in motor vehicles, smoke gases that are harmful to health can be produced due to the various flammable materials and substances. In general, caution should be exercised during fires because plastics, composites, and liquids can release toxic fumes at high temperatures. It is not uncommon for plastics to become drippable in vehicle fires at certain temperatures.

⚠ WARNING

Personal protective equipment (PPE) must always be adapted to the situation. There is a risk of suffocation and poisoning if fumes are inhaled. For this reason, self-contained breathing equipment must be used when working in an exposed position.

Electric vehicles can be moved with the gear in position "N" and the parking brake released. Care must be taken to ensure that the vehicle does not roll away in an uncontrolled manner. To engage gear position "N", the ignition must be switched on and the brake pedal depressed.

Extinguish a vehicle fire that does not involve the high-voltage battery using typical firefighting procedures for a vehicle fire according to the domestic fire department guidelines.

When a hybrid/electric vehicle catches fire, it is possible that the high-voltage battery is also ignited, e.g., due to prolonged exposure to heat. Large quantities of water have proven to be a suitable cooling and extinguishing agent in a fire involving a lithium-ion high-voltage battery.

Depending on the type of battery, it is possible that a self-igniting high-voltage battery cannot be completely extinguished but can re-ignite until it has burned itself out. In this case, further permanent extinguishing with water until the fire does not spread further, and controlled burning is possible should cool the high-voltage battery.

Unsuitable extinguishing agents are e.g., powder extinguishers because, on the one hand, the necessary safety distance cannot be maintained during use, and on the other hand, the chemical reaction (thermal runaway) cannot be stopped.

⚠ CAUTION

Do not use powder extinguishers, as these extinguish the flame but do not the chemical reaction (thermal runaway).

2 Vehicle partially or completely submerged

When recovering vehicles that are partially or completely submerged in water, there is, in principle, no difference between conventional vehicles and vehicles with a high-voltage electrical system. The high-voltage vehicle electrical system, which is surrounded by water, does not pose any increased risk of electric shock. Salvage the partially or fully submerged vehicle according to fire department guidelines. Pull the vehicle out of the water as far as possible.

For this reason, the vehicle's high-voltage system should, if possible, be deactivated and secured against reconnection according to the specified shutdown procedure after recovery from the water (see chapter 4.2).

When deactivating the high-voltage drive system on vehicles recovered from the water, appropriate personal protective equipment (PPE) must be worn, e.g., eye protection and insulated gloves (observe protection class).

⚠ WARNING

Make sure that the ignition is switched off. Switching on the ignition should be avoided if the vehicle is partially or completely immersed in water. If possible, manually deactivate the high-voltage system and disconnect all high-voltage and 12/24V batteries.

The high-voltage battery is located on the underbody of the vehicle. When using rescue equipment, ensure the high-voltage battery is not damaged or deformed.

After a certain time, components corrode due to an electrochemical reaction with water, e.g., electrical cables and circuit boards. A short circuit can cause a vehicle fire under certain circumstances.

⚠ WARNING

Fire hazard due to a short circuit in a vehicle that was partially or completely submerged in water.

3 Damaged high-voltage system

High-voltage links

A special high-voltage electrical system links all high-voltage components. High-voltage cables are immediately recognizable and clearly distinguishable from the wiring of the 12/24-volt vehicle electrical system due to their larger cross-section and the orange protective sheathing.

The connectors and plugs on the high-voltage components are designed to be touch-protected and are also either screwed and/or monitored by a separate signal line (interlock - HVIL).

Insulation monitoring of the high-voltage vehicle electrical system represents a further safety device. The high-voltage electrical system is switched off and discharged if a serious insulation fault is detected. The high-voltage electrical system is completely electrically isolated from the body.

Coolant pipes

Unlike conventional vehicles, vehicles with a high-voltage electrical system have coolant lines running along almost the entire vehicle length. Coolant can flow from the rear axle drive module when recovering an accident vehicle. If the coolant lines are damaged, collect the coolant.

⚠ CAUTION

The coolant may still be hot. There is a risk of burns.

High-voltage components

The following high-voltage components should be checked for damage:

- Charging port
- Onboard charger (OBC) and DC box DCB
- DC/DC converter
- Electric drive module (eDM)
- Power distribution unit (PDU)
- PTC heater (driver's cab)
- PTC heater (high voltage battery)
- HV A/C refrigerant compressor
- High-voltage traction batteries

If the vehicle is equipped with a body, also the ePTO and mPTO need to be checked.

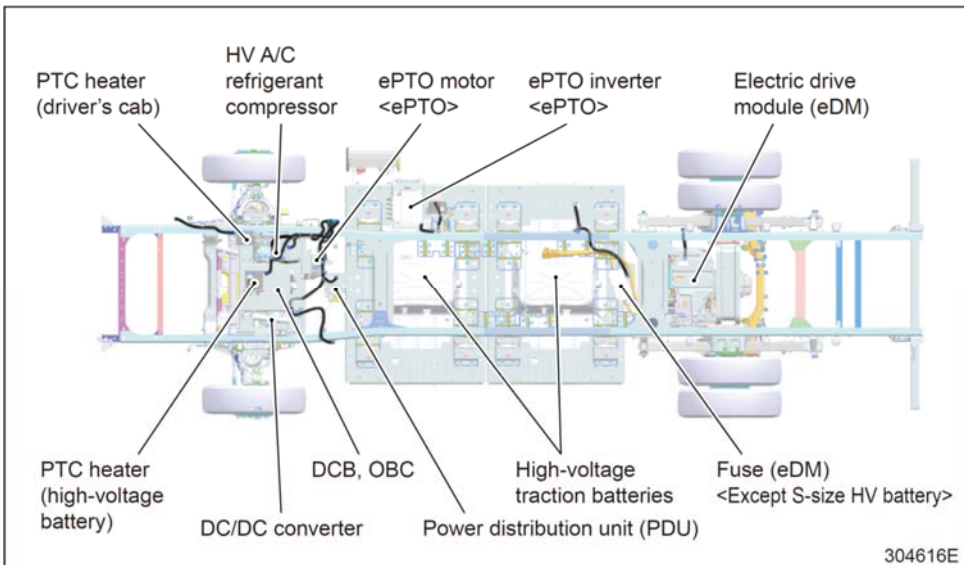
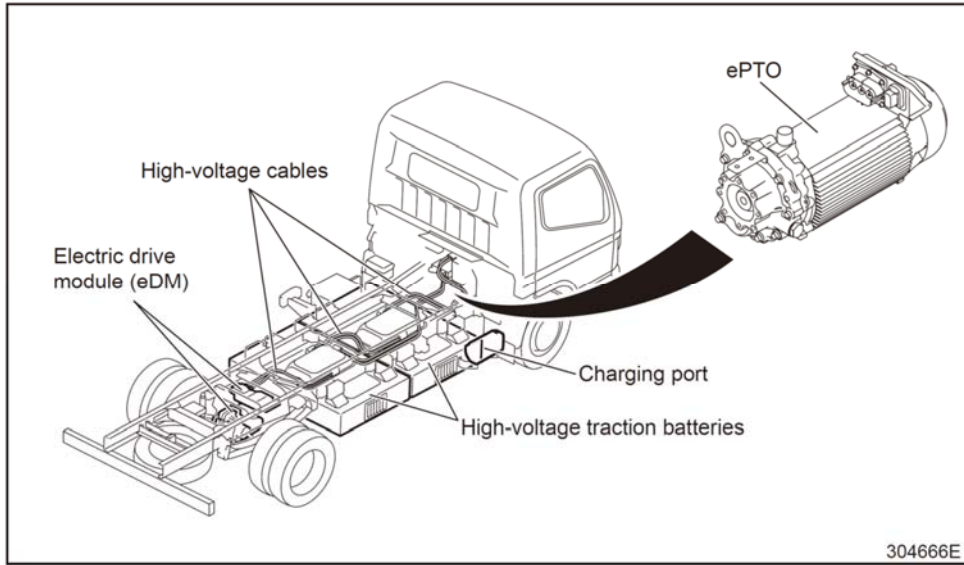

⚠ WARNING

Defective or damaged high-voltage components must always be replaced and must not be reused. The same applies to defective components carrying high-voltage, cables and connectors.

4 Damaged lithium-ion high-voltage batteries

Technical Information

Mitsubishi Fuso vehicles with high-voltage electrical systems use lithium-ion (LIB) battery cells as high-voltage batteries. A high-voltage battery (LIB) is basically flammable due to its material components. Additional design measures on the high-voltage battery's housing and the high-voltage battery's installation location further improve safety. Due to these safety measures, no increased fire risk compared to conventional vehicles is to be expected.

The high-voltage battery as a whole and individual battery cells are equipped with mechanical safety devices that are triggered in the event of a temperature and pressure increase in the high-voltage battery (e.g., due to fire) and contribute to targeted degassing and, thus, pressure relief. This virtually rules out the possibility of the high-voltage battery bursting.

Each high-voltage battery has a battery management system (BMS) for monitoring and control. The BMS checks the status of the high-voltage battery in all driving modes. In case of a system fault, the BMS puts the battery connections and the high-voltage vehicle electrical system into a de-energized state by opening the contactors.

NOTE:

The high-voltage battery remains electrically charged even after the high-voltage vehicle electrical system has switched off and discharged.

The temperature of the high-voltage batteries is monitored. If the temperature of a high-voltage battery exceeds a defined value, a warning message is issued.

Damaged or deformed high-voltage battery

A damaged high-voltage battery can cause an internal short circuit of the lithium-ion cells, and the stored chemical energy can escape uncontrollably in the form of thermal energy. This poses a risk of fire or explosion. External signs such as smoke development or fire do not necessarily have to be recognizable in this case. Nevertheless, a critical condition of the high-voltage battery must be assumed. The condition of the high-voltage battery should therefore be monitored (e.g., for smoke development or a significant increase in the temperature of the high-voltage battery housing compared to the ambient temperature), as subsequent self-ignition cannot be ruled out in the case of lithium-ion high-voltage batteries.

Battery Electrolyte

- Battery electrolyte is irritant, flammable, and potentially corrosive.
- Conventional binders should be used in case of leakage.
- Skin contact with the battery electrolyte and inhalation of gases released as a result of chemical reactions of the escaping battery electrolyte must be avoided at all costs.
- Always adapt the personal protective equipment (PPE) according to the situation.
- In case of contact with ingredients of the high-voltage battery or its gases, rinse affected skin areas with plenty of water.
- Remove and clean contaminated clothing.
- Consult a doctor as soon as possible.

NOTE:

Leaking liquids from high-voltage batteries are mostly coolant and not battery electrolytes. Battery electrolytes are only present in small quantities (ml) distributed in the individual cells.

If a battery electrolyte, as well as a battery electrolyte mixed with water, is swallowed, symptoms of poisoning such as headache, dizziness, stomach pain, respiratory paralysis, unconsciousness, vomiting, chemical burns, and convulsions are to be expected.

Contact with the battery electrolyte/mist causes severe burns to the skin, eyes, and mucous membranes. Deep tissue damage can occur.

Externally not damaged high-voltage battery

Even in the case of a high-voltage battery that is not externally damaged, an internal short circuit of the lithium-ion cells can occur, and the stored chemical energy can escape uncontrollably in the form of thermal energy. This poses a fire hazard.

External signs such as smoke development or fire do not necessarily have to be recognizable in this case. Nevertheless, a critical condition of the high-voltage battery must be assumed. The condition of the high-voltage battery should therefore be monitored (e.g. for smoke development or a significant increase in the temperature of the high-voltage battery housing compared to the ambient temperature), as spontaneous ignition cannot be ruled out later in the case of lithium-ion batteries.

Handling of lithium-ion high-voltage batteries

If there is an acute hazard at a lithium-ion battery due to smoke, fire, heat development, or electrolyte leakage (visible/smellable), immediately make an emergency call to the respective location- and country-specific emergency number. Do not touch the lithium-ion batteries, and clear the danger zone.

Depending on the battery's condition, Mitsubishi Fuso standards require special qualifications for handling lithium-ion batteries. You can obtain the required qualification at our Fuso Academy, among other places. Whether additional country-specific regulations and legislation require further special qualifications/instructions, please get in touch with your respective distributor or department.

Furthermore, the following measures must be observed:

- Keep batteries and battery electrolyte away from unauthorized persons.
- Fire, sparks, and smoking are prohibited in the vicinity of high-voltage batteries.
- Do not apply mechanical pressure to the batteries.
- Do not charge or reinstall batteries with damaged housings.
- Ensure that the degassing/electrolyte outlet openings are not improperly closed.
- Only fill leaked battery electrolyte into suitable and appropriately labeled containers.
- Do not place any tools or other conductive objects on the battery, risk of a short circuit!
- In case of electrolyte leakage, wear acid-protective clothing and safety goggles with side shields.
- Always wear full personal protective equipment when batteries are open and damaged.

 DANGER

LITHIUM-ION HIGH-VOLTAGE BATTERIES MUST NOT BE UNDER ANY MECHANICAL PRESSURE AND MUST BE SECURED AGAINST DAMAGE. THERE IS A RISK OF FIRE/EXPLOSION.

Outgassing of a high-voltage battery

An outgassing high-voltage battery poses an acute fire hazard.

NOTE:

The bursting of exposed defective cells with accompanying exothermic reactions cannot be ruled out.

The resulting flue gas contains toxic and corrosive components such as small amounts of hydrofluoric acid.

When outgassing a high-voltage battery, note the following:

- Escaping gases are irritant, flammable, hot, potentially corrosive, and toxic and should, therefore, never be inhaled.
- Always control the rescue process.
- In addition, extend the danger zone around the vehicle.
- As far as possible, constantly cool the outgassing high-voltage battery with water.

NOTE:

Escaping gases can usually also be perceived by a strong, acrid odor.

For further information on high-voltage batteries, such as their storage, transport, and handling, contact an authorised MITSUBISHI FUSO distributor or dealer.

5 Fire fighting recommendation

With the metal housing of the high-voltage battery closed:

- Object temperature up to 80°C/176°F: Cool with plenty of water from a safe distance. Continue to monitor as temperature rises.
- Object temperature above 80°C/176°F: Extinguish (cool) with plenty of water from a safe distance.

With the metal housing of the high-voltage battery open:

- Extinguishing (cooling) with a lot of water from a safe distance

If possible, move the vehicle or the high-voltage battery to a safe place outdoors (observation point). Allow the high-voltage battery to burn down as controlled as possible while preventing the fire from spreading further.

6 Post-accident countermeasures and preparation

Handling of a damaged high-voltage battery:

- Damaged high-voltage batteries must be left in the vehicle and safely transported to a specialist workshop or quarantine site.
- Temperature measurement on the surface of the high-voltage battery, e.g., with a thermometer or an infrared thermal imaging camera, must yield < 60°C/140°F.
- The vehicle must be transported safely and directly to a specialized workshop or quarantine site and parked in a quarantine area/secured outdoor area away from buildings and structures.
- Individual high-voltage battery parts or damaged high-voltage batteries must be taken up in a special transport container for "high-voltage batteries that are not safe for transport" and transported to a specialist workshop or quarantine site.

Handling of damaged electric vehicles:

- Accident-damaged vehicles with high-voltage electrical systems must be parked in a cordoned-off area in the open air with sufficient distance to other vehicles, buildings, combustible objects, and combustible substrates for fire protection reasons.
- Parked accident vehicles with high-voltage electrical systems with high-voltage components directly exposed to the weather must be covered with a weatherproof cover.
- The vehicle must be marked accordingly.
- Alternatively, accident-damaged vehicles with high-voltage electrical systems can be parked in designated fire protection systems (quarantine area).
- Parking a vehicle with a damaged high-voltage electrical system in a closed workshop is not recommended under any circumstances.

7 Towing, transport, roadside assistance

Towing or vehicle transport should always be carried out in accordance with the manufacturer's instructions, see the vehicle operation manual.

The vehicle must be transported in accordance with the applicable guidelines for towing and roadside assistance companies. Always observe the national regulations and standards when towing and transporting electric vehicles.

In particular, for vehicles with alternative drives, country-specific and/or operator-specific regulations must be observed, e.g., tunnel regulations or guidelines for storage in enclosed spaces.

To switch to gear position "N", the vehicle's electric 12/24V system must be supplied with voltage for a short time. The vehicle can then be removed from the immediate danger zone at walking speed.

In addition, consider the following:

- During the towing operation, the rear axle must not be exposed to any kind of movement.
- Tow vehicle with a flatbed vehicle (car) or low-loader (truck) if possible.
- Before towing, the high-voltage vehicle electrical system must be deactivated (e.g., switch off the ignition, use the existing high-voltage cut-off device if necessary, and disconnect 12/24 V).

NOTE:

Further information on towing can be found in the vehicle operating manual.

Recommendation for towing a vehicle with a high-voltage drive system

Once it has been ensured that there is no further danger, the vehicle can be made accessible to the following emergency services (e.g., police, tow truck). Before the vehicle is made accessible to the rescue teams or the scene is left, the high-voltage battery must have cooled down completely. Always point out to the following rescue forces that the battery can re-ignite.

- Before the vehicle is loaded, the high-voltage electrical system should be deactivated.
- When handing over the vehicle, e.g., to representatives of the authorities, towing/recovery companies, workshops, or disposal companies, the drive type of the vehicle and the fire-fighting measures taken (e.g., deactivation of the high-voltage electrical system) must be reported. In particular, reference must be made to a possible hazard due to damaged high-voltage components or high-voltage components that have come into contact with water (e.g., electric shock or fire risk, also with a time delay, due to the high-voltage battery).
- National regulations/standards must be observed for loading and transport (transport of dangerous goods).
- Taking into account measures already taken and the degree of damage to the vehicle, the towing/recovery company must ensure the road safety of the transport. A possible hazard due to damaged high-voltage components (e.g. electric shock or fire risk due to the high-voltage battery) must be taken into account.
- When lifting with a crane/truck jack, working with a cable winch or loading, ensure that no high-voltage components are or become damaged.
- Various measures must be carried out in order to safely park an accident vehicle. If the vehicle is taken to a workshop or quarantine area, the responsible specialist personnel must be informed of the measures already carried out (e.g. high-voltage cut-off device was actuated).

Voltage deactivation of the high-voltage vehicle electrical system in the event of an accident.

The following measures realize the system-side protection against hazards of the electrical systems:

- All components that are operated with high voltage are equipped with contact protection. This, if undamaged, ensures adequate protection against the hazards of the electrical system.
- Automatic shutdown in the event of a short circuit to avoid damage to high-voltage cables due to overload.
- Deactivating the high-voltage vehicle electrical system and electric drive system depends on the severity and type of accident by disconnecting the high-voltage vehicle electrical system from the energy storage system.
- The high-voltage electrical system is actively discharged when the ignition is switched off, a crash is detected, or the emergency stop is activated (pressed).

Personal protective equipment of the fire department for use on vehicles with high-voltage electrical systems:

- Safety helmet, with visor closed
- Full duty gear
- Kevlar gloves (thermal protection)
- Insulated gloves with arc protection
- Safety footwear (duty footwear)

Possible procedures depending on the Damage pattern

Copy this page and place it in a visible location on the outside of vehicles that are being subject to rescue operations or are in the operations area, to alert people nearby.



90ELT0009
' 23-3